

Tutorial on MPI: The Message-Passing Interface

William Gropp



Mathematics and Computer Science Division

Argonne National Laboratory

Argonne, IL 60439

gropp@mcs.anl.gov

Course Outline

- Background on Parallel Computing
- Getting Started
- MPI Basics
- Intermediate MPI
- Tools for writing libraries
- Final comments

Thanks to Rusty Lusk for some of the material in this tutorial.

This tutorial may be used in conjunction with the book “Using MPI” which contains detailed descriptions of the use of the MPI routines.



Material that beings with this symbol is ‘advanced’ and may be skipped on a first reading.

Background

- Parallel Computing
- Communicating with other processes
- Cooperative operations
- One-sided operations
- The MPI process

Parallel Computing

- Separate workers or processes
- Interact by exchanging information

Types of parallel computing

All use different data for each worker

Data-parallel Same operations on different data. Also called SIMD

SPMD Same program, different data

MIMD Different programs, different data

SPMD and MIMD are essentially the same because any MIMD can be made SPMD

SIMD is also equivalent, but in a less practical sense.

MPI is primarily for SPMD/MIMD. HPF is an example of a SIMD interface.

Communicating with other processes

Data must be exchanged with other workers

- Cooperative — all parties agree to transfer data
- One sided — one worker performs transfer of data

Cooperative operations

Message-passing is an approach that makes the exchange of data cooperative.

Data must both be explicitly sent and received.

An advantage is that any change in the *receiver's* memory is made with the receiver's participation.

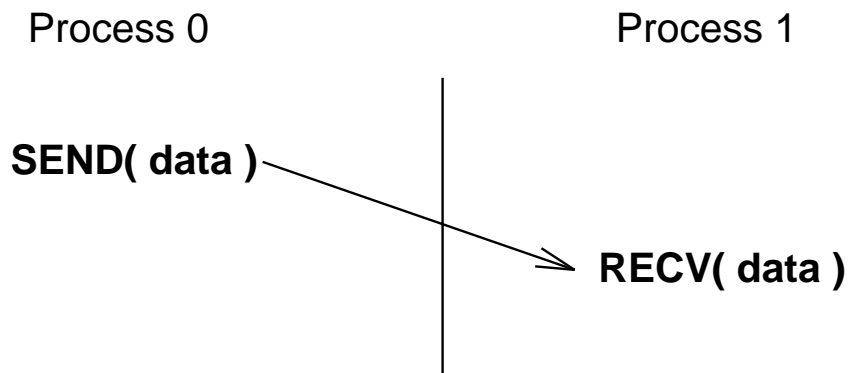

One-sided operations

One-sided operations between parallel processes include remote memory reads and writes.

An advantage is that data can be accessed without waiting for another process

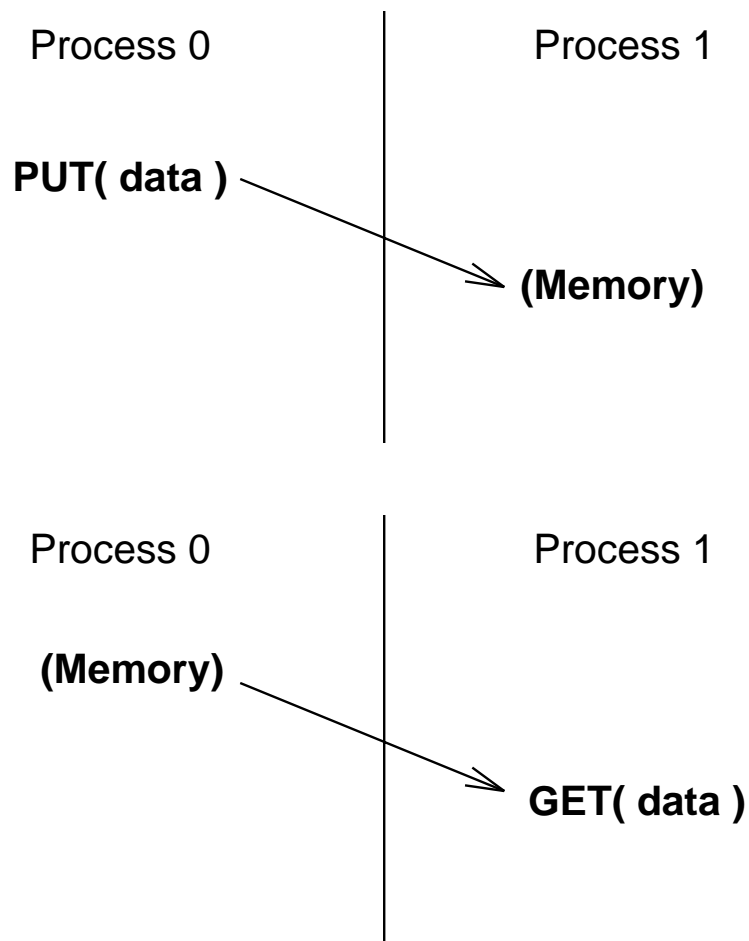

Class Example

Take a pad of paper. Algorithm: Initialize with the number of neighbors you have

- Compute average of your neighbor's values and subtract from your value. Make that your new value.
- Repeat until done

Questions

1. How do you get values from your neighbors?
2. Which step or iteration do they correspond to?
Do you know? Do you care?
3. How do you decide when you are done?

Hardware models

The previous example illustrates the hardware models by how data is exchanged among workers.

- Distributed memory (e.g., Paragon, IBM SPx, workstation network)
- Shared memory (e.g., SGI Power Challenge, Cray T3D)

Either may be used with SIMD or MIMD software models.

 *All memory is distributed.*

What is MPI?

- A *message-passing library specification*
 - message-passing model
 - not a compiler specification
 - not a specific product
- For parallel computers, clusters, and heterogeneous networks
- Full-featured
- Designed to permit (unleash?) the development of parallel software libraries
- Designed to provide access to advanced parallel hardware for
 - end users
 - library writers
 - tool developers

Motivation for a New Design

- Message Passing now mature as programming paradigm
 - well understood
 - efficient match to hardware
 - many applications
- Vendor systems not portable
- Portable systems are mostly research projects
 - incomplete
 - lack vendor support
 - not at most efficient level

Motivation (cont.)

Few systems offer the full range of desired features.

- modularity (for libraries)
- access to peak performance
- portability
- heterogeneity
- subgroups
- topologies
- performance measurement tools

The MPI Process

- Began at Williamsburg Workshop in April, 1992
- Organized at Supercomputing '92 (November)
- Followed HPF format and process
- Met every six weeks for two days
- Extensive, open email discussions
- Drafts, readings, votes
- Pre-final draft distributed at Supercomputing '93
- Two-month public comment period
- Final version of draft in May, 1994
- Widely available now on the Web, ftp sites, netlib (<http://www.mcs.anl.gov/mpi/index.html>)
- Public implementations available
- Vendor implementations coming soon

Who Designed MPI?

- Broad participation
- Vendors
 - IBM, Intel, TMC, Meiko, Cray, Convex, Ncube
- Library writers
 - PVM, p4, Zipcode, TCGMSG, Chameleon, Express, Linda
- Application specialists and consultants

Companies	Laboratories	Universities
ARCO	ANL	UC Santa Barbara
Convex	GMD	Syracuse U
Cray Res	LANL	Michigan State U
IBM	LLNL	Oregon Grad Inst
Intel	NOAA	U of New Mexico
KAI	NSF	Miss. State U.
Meiko	ORNL	U of Southampton
NAG	PNL	U of Colorado
nCUBE	Sandia	Yale U
ParaSoft	SDSC	U of Tennessee
Shell	SRC	U of Maryland
TMC		Western Mich U
		U of Edinburgh
		Cornell U.
		Rice U.
		U of San Francisco

Features of MPI

- General
 - Communicators combine context and group for message security
 - Thread safety
- Point-to-point communication
 - Structured buffers and derived datatypes, heterogeneity
 - Modes: normal (blocking and non-blocking), synchronous, ready (to allow access to fast protocols), buffered
- Collective
 - Both built-in and user-defined collective operations
 - Large number of data movement routines
 - Subgroups defined directly or by topology

Features of MPI (cont.)

- Application-oriented process topologies
 - Built-in support for grids and graphs (uses groups)
- Profiling
 - Hooks allow users to intercept MPI calls to install their own tools
- Environmental
 - inquiry
 - error control

Features not in MPI

- Non-message-passing concepts not included:
 - process management
 - remote memory transfers
 - active messages
 - threads
 - virtual shared memory
- MPI does not address these issues, but has tried to remain compatible with these ideas (e.g. thread safety as a goal, intercommunicators)

Is MPI Large or Small?

- MPI is large (125 functions)
 - MPI's extensive functionality requires many functions
 - Number of functions not necessarily a measure of complexity
- MPI is small (6 functions)
 - Many parallel programs can be written with just 6 basic functions.
- MPI is just right
 - One can access flexibility when it is required.
 - One need not master all parts of MPI to use it.

Where to use MPI?

- You need a portable parallel program
- You are writing a parallel library
- You have irregular or dynamic data relationships that do not fit a data parallel model

Where *not* to use MPI:

- You can use HPF or a parallel Fortran 90
- You don't need parallelism at all
- You can use libraries (which may be written in MPI)

Why learn MPI?

- Portable
- Expressive
- Good way to learn about subtle issues in parallel computing

Getting started

- Writing MPI programs
- Compiling and linking
- Running MPI programs
- More information
 - *Using MPI* by William Gropp, Ewing Lusk, and Anthony Skjellum,
 - The LAM companion to “Using MPI...” by Zdzislaw Meglicki
 - *Designing and Building Parallel Programs* by Ian Foster.
 - A Tutorial/User’s Guide for MPI by Peter Pacheco
(<ftp://math.usfca.edu/pub/MPI/mpi.guide.ps>)
 - The MPI standard and other information is available at <http://www.mcs.anl.gov/mpi>. Also the source for several implementations.

Writing MPI programs

```
#include "mpi.h"
#include <stdio.h>

int main( argc, argv )
int argc;
char **argv;
{
MPI_Init( &argc, &argv );
printf( "Hello world\n" );
MPI_Finalize();
return 0;
}
```

Commentary

- `#include "mpi.h"` provides basic MPI definitions and types
- `MPI_Init` starts MPI
- `MPI_Finalize` exits MPI
- Note that all non-MPI routines are local; thus the `printf` run on each process

Compiling and linking

For simple programs, special compiler commands can be used. For large projects, it is best to use a standard Makefile.

The MPICH implementation provides the commands `mpicc` and `mpif77` as well as 'Makefile' examples in `'/usr/local/mpi/examples/Makefile.in'`

Special compilation commands

The commands

```
mpicc -o first first.c  
mpif77 -o firstf firstf.f
```

may be used to build simple programs when using MPICH.

These provide special options that exploit the profiling features of MPI

- mpilog** Generate log files of MPI calls
- mpitrace** Trace execution of MPI calls
- mpianim** Real-time animation of MPI (not available on all systems)

There are specific to the MPICH implementation; other implementations may provide similar commands (e.g., `mpcc` and `mpxlf` on IBM SP2).

Using Makefiles

The file 'Makefile.in' is a *template* Makefile. The program (script) 'mpireconfig' translates this to a Makefile for a particular system. This allows you to use the same Makefile for a network of workstations and a massively parallel computer, even when they use different compilers, libraries, and linker options.

mpireconfig Makefile

Note that you must have 'mpireconfig' in your PATH.

Sample Makefile.in

User configurable options

```
ARCH          = @ARCH@
COMM          = @COMM@
INSTALL_DIR   = @INSTALL_DIR@
CC            = @CC@
F77           = @F77@
CLINKER       = @CLINKER@
FLINKER       = @FLINKER@
OPTFLAGS     = @OPTFLAGS@
#
LIB_PATH      = -L$(INSTALL_DIR)/lib/$(ARCH)/$(COMM)
FLIB_PATH     =
@FLIB_PATH_LEADER@$(INSTALL_DIR)/lib/$(ARCH)/$(COMM)
LIB_LIST      = @LIB_LIST@
#
INCLUDE_DIR   = @INCLUDE_PATH@ -I$(INSTALL_DIR)/include

### End User configurable options ###
```

Sample Makefile.in (con't)

```
CFLAGS = @CFLAGS@ $(OPTFLAGS) $(INCLUDE_DIR) -DMPI_$(ARCH)
FFLAGS = @FFLAGS@ $(INCLUDE_DIR) $(OPTFLAGS)
LIBS = $(LIB_PATH) $(LIB_LIST)
FLIBS = $(FLIB_PATH) $(LIB_LIST)
EXECS = hello

default: hello

all: $(EXECS)

hello: hello.o $(INSTALL_DIR)/include/mpi.h
      $(CLINKER) $(OPTFLAGS) -o hello hello.o \
      $(LIB_PATH) $(LIB_LIST) -lm

clean:
      /bin/rm -f *.o *~ PI* $(EXECS)

.c.o:
      $(CC) $(CFLAGS) -c $.c

.f.o:
      $(F77) $(FFLAGS) -c $.f
```

Running MPI programs

```
mpirun -np 2 hello
```

'mpirun' is not part of the standard, but some version of it is common with several MPI implementations. The version shown here is for the MPICH implementation of MPI.

⚠ *Just as Fortran does not specify how Fortran programs are started, MPI does not specify how MPI programs are started.*

⚠ *The option `-t` shows the commands that `mpirun` would execute; you can use this to find out how `mpirun` starts programs on your system. The option `-help` shows all options to `mpirun`.*

Finding out about the environment

Two of the first questions asked in a parallel program are: How many processes are there? and Who am I?

How many is answered with `MPI_Comm_size` and who am I is answered with `MPI_Comm_rank`.

The rank is a number between zero and `size-1`.

A simple program

```
#include "mpi.h"
#include <stdio.h>

int main( argc, argv )
int argc;
char **argv;
{
int rank, size;
MPI_Init( &argc, &argv );
MPI_Comm_rank( MPI_COMM_WORLD, &rank );
MPI_Comm_size( MPI_COMM_WORLD, &size );
printf( "Hello world! I'm %d of %d\n",
        rank, size );
MPI_Finalize();
return 0;
}
```

Caveats

 *These sample programs have been kept as simple as possible by assuming that all processes can do output. Not all parallel systems provide this feature, and MPI provides a way to handle this case.*

Exercise - Getting Started

Objective: Learn how to login, write, compile, and run a simple MPI program.

Run the “Hello world” programs. Try two different parallel computers. What does the output look like?

Sending and Receiving messages

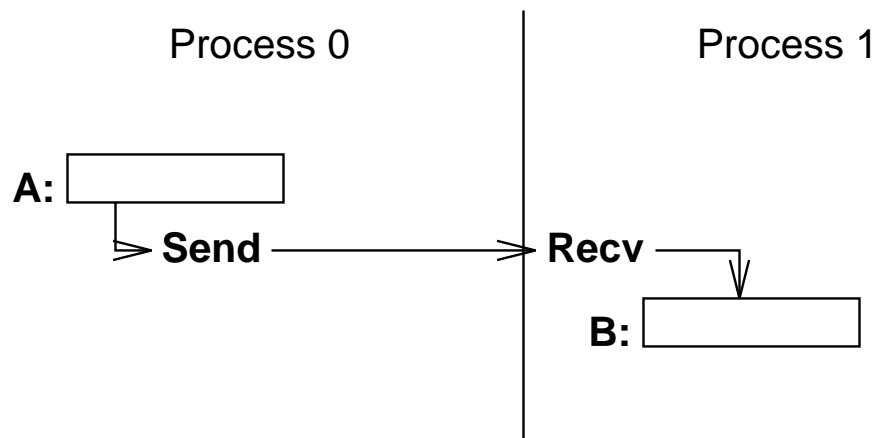

Questions:

- To whom is data sent?
- What is sent?
- How does the receiver identify it?

Current Message-Passing

- A typical blocking send looks like

```
send( dest, type, address, length )
```

where

- `dest` is an integer identifier representing the process to receive the message.
- `type` is a nonnegative integer that the destination can use to selectively screen messages.
- `(address, length)` describes a contiguous area in memory containing the message to be sent.

and

- A typical global operation looks like:

```
broadcast( type, address, length )
```

- All of these specifications are a good match to hardware, easy to understand, but too inflexible.

The Buffer

Sending and receiving only a contiguous array of bytes:

- hides the real data structure from hardware which might be able to handle it directly
- requires pre-packing dispersed data
 - rows of a matrix stored columnwise
 - general collections of structures
- prevents communications between machines with different representations (even lengths) for same data type

Generalizing the Buffer Description

- Specified in MPI by *starting address*, *datatype*, and *count*, where datatype is:
 - elementary (all C and Fortran datatypes)
 - contiguous array of datatypes
 - strided blocks of datatypes
 - indexed array of blocks of datatypes
 - general structure
- Datatypes are constructed recursively.
- Specifications of elementary datatypes allows heterogeneous communication.
- Elimination of length in favor of count is clearer.
- Specifying application-oriented layout of data allows maximal use of special hardware.

Generalizing the Type

- A single type field is too constraining. Often overloaded to provide needed flexibility.
- Problems:
 - under user control
 - wild cards allowed (`MPI_ANY_TAG`)
 - library use conflicts with user and with other libraries

Sample Program using Library Calls

Sub1 and Sub2 are from different libraries.

```
Sub1();
```

```
Sub2();
```

Sub1a and Sub1b are from the same library

```
Sub1a();
```

```
Sub2();
```

```
Sub1b();
```

Thanks to Marc Snir for the following four examples

Correct Execution of Library Calls

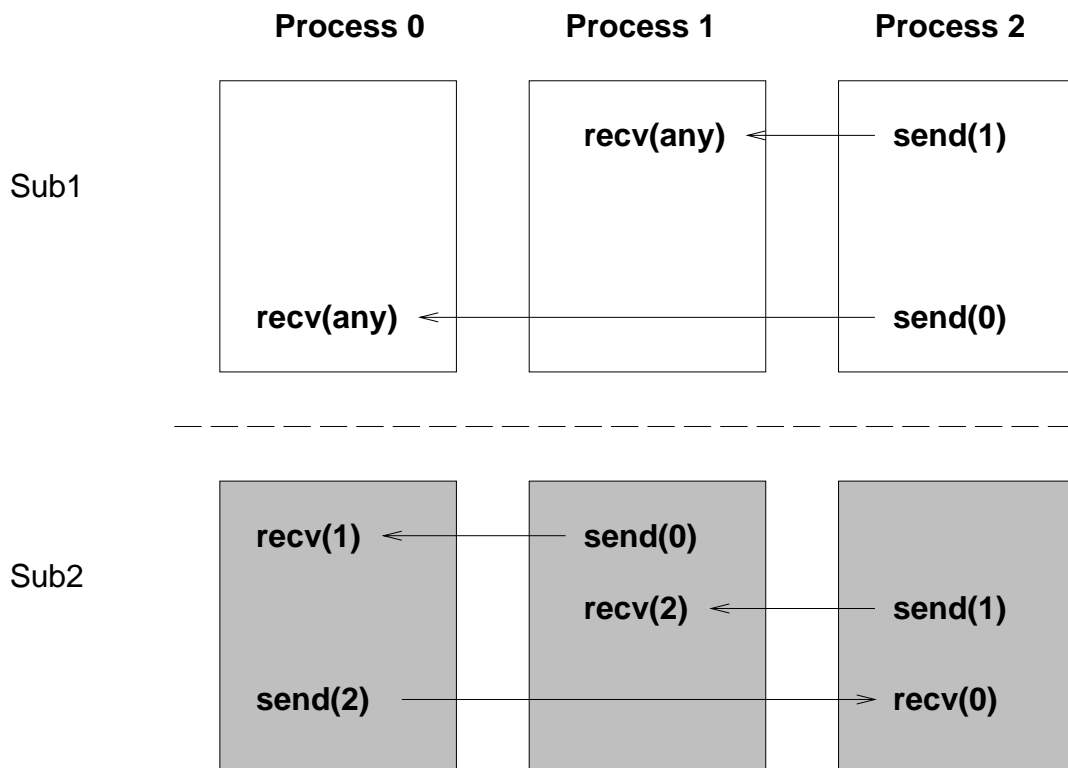

Incorrect Execution of Library Calls

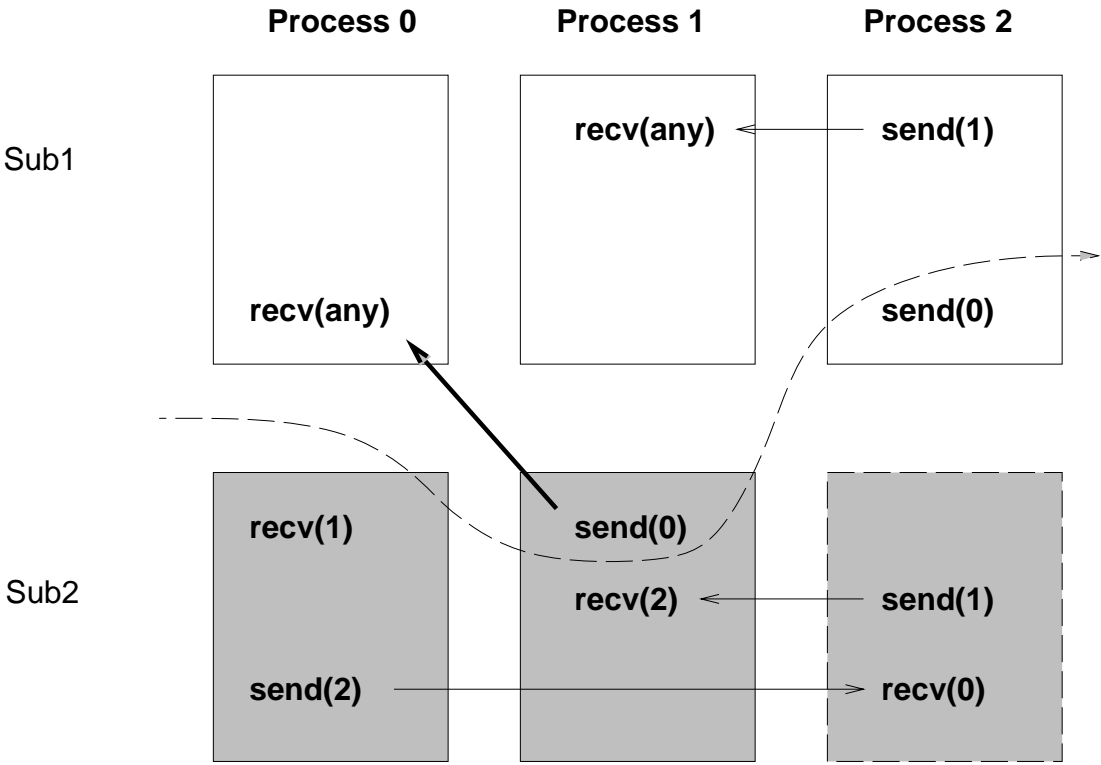

Correct Execution of Library Calls with Pending Communication

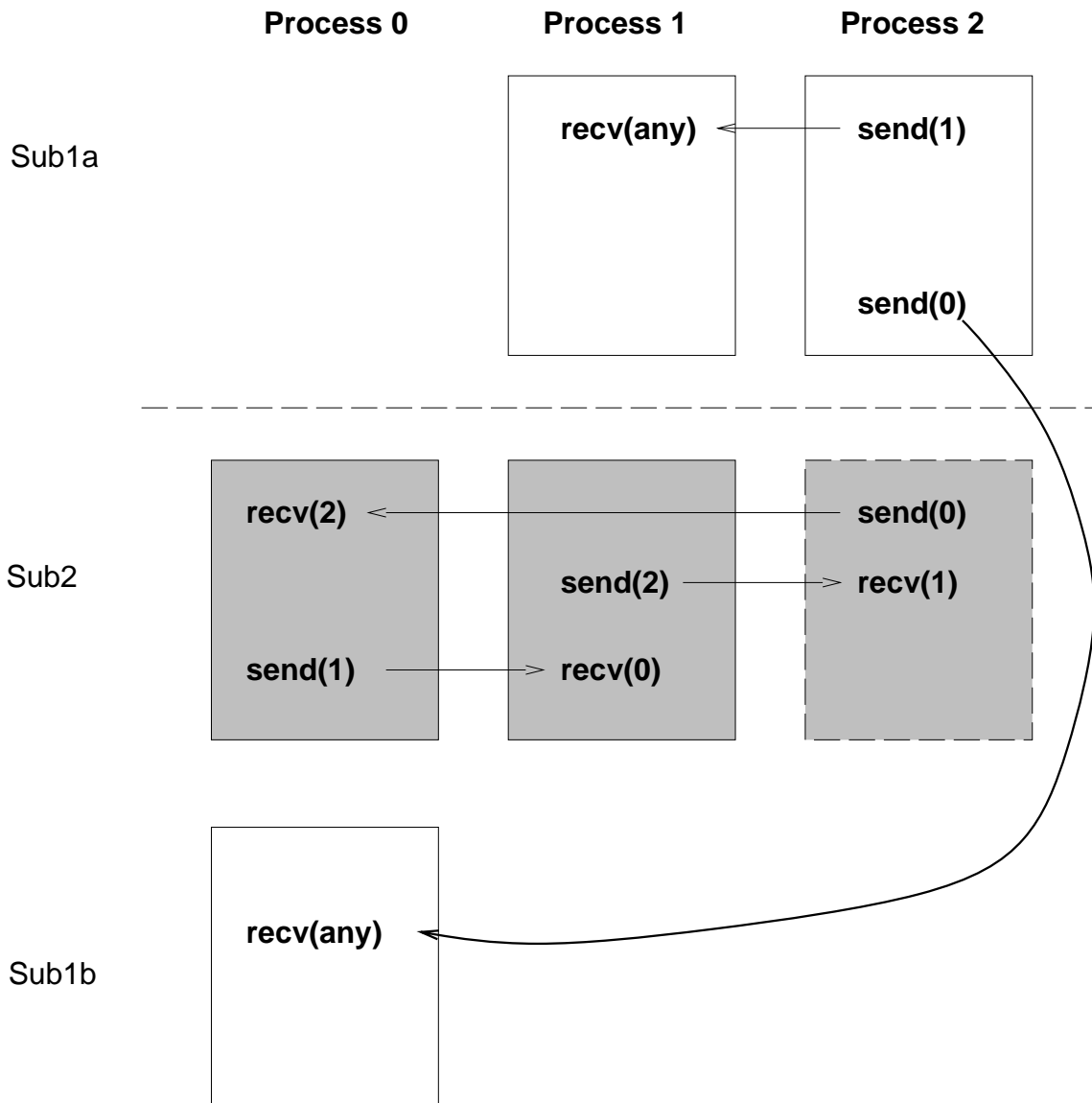

Incorrect Execution of Library Calls with Pending Communication

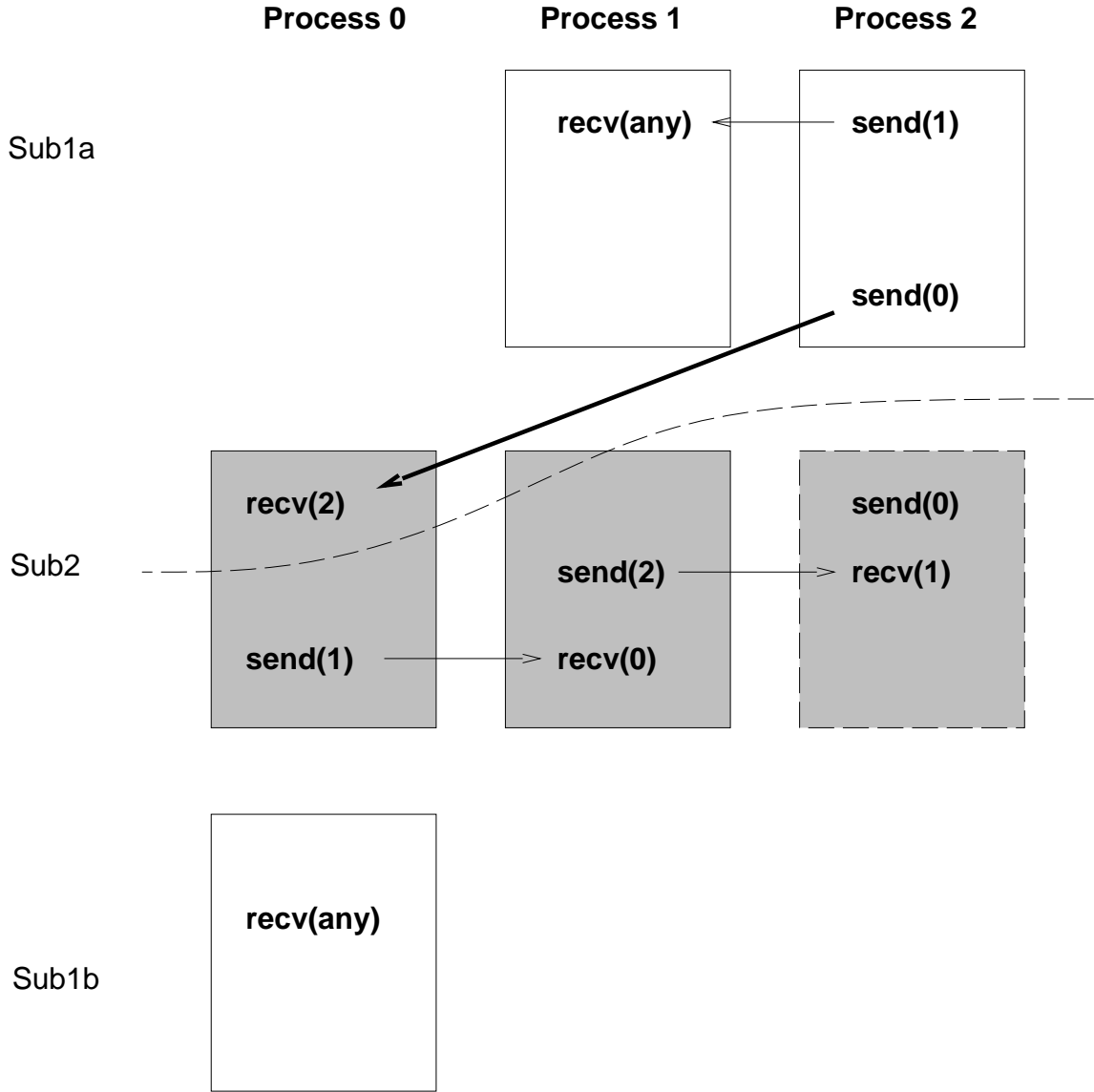

Solution to the type problem

- A separate communication *context* for each family of messages, used for queueing and matching. (This has often been simulated in the past by overloading the tag field.)
- No wild cards allowed, for security
- Allocated by the system, for security
- Types (*tags*, in MPI) retained for normal use (wild cards OK)

Delimiting Scope of Communication

- Separate groups of processes working on subproblems
 - Merging of process name space interferes with modularity
 - “Local” process identifiers desirable
- Parallel invocation of parallel libraries
 - Messages from application must be kept separate from messages internal to library.
 - Knowledge of library message types interferes with modularity.
 - Synchronizing before and after library calls is undesirable.

Generalizing the Process Identifier

- Collective operations typically operated on all processes (although some systems provide subgroups).
- This is too restrictive (e.g., need minimum over a column or a sum across a row, of processes)
- MPI provides *groups* of processes
 - initial “all” group
 - group management routines (build, delete groups)
- All communication (not just collective operations) takes place in groups.
- A group and a context are combined in a *communicator*.
- Source/destination in send/receive operations refer to *rank* in group associated with a given communicator. `MPI_ANY_SOURCE` permitted in a receive.

MPI Basic Send/Receive

Thus the basic (blocking) send has become:

```
MPI_Send( start, count, datatype, dest, tag,  
          comm )
```

and the receive:

```
MPI_Recv(start, count, datatype, source, tag,  
         comm, status)
```

The source, tag, and count of the message actually received can be retrieved from `status`.

Two simple collective operations:

```
MPI_Bcast(start, count, datatype, root, comm)  
MPI_Reduce(start, result, count, datatype,  
           operation, root, comm)
```

Getting information about a message

```
MPI_Status status;  
MPI_Recv( ..., &status );  
... status.MPI_TAG;  
... status.MPI_SOURCE;  
MPI_Get_count( &status, datatype, &count );
```

MPI_TAG and MPI_SOURCE primarily of use when MPI_ANY_TAG and/or MPI_ANY_SOURCE in the receive.

MPI_Get_count may be used to determine how much data of a particular type was received.

Simple Fortran example

```
program main
include 'mpif.h'

integer rank, size, to, from, tag, count, i, ierr
integer src, dest
integer st_source, st_tag, st_count
integer status(MPI_STATUS_SIZE)
double precision data(100)

call MPI_INIT( ierr )
call MPI_COMM_RANK( MPI_COMM_WORLD, rank, ierr )
call MPI_COMM_SIZE( MPI_COMM_WORLD, size, ierr )
print *, 'Process ', rank, ' of ', size, ' is alive'
dest = size - 1
src = 0

C
if (rank .eq. src) then
  to      = dest
  count   = 10
  tag     = 2001
  do 10 i=1, 10
10      data(i) = i
      call MPI_SEND( data, count, MPI_DOUBLE_PRECISION, to,
+                tag, MPI_COMM_WORLD, ierr )
  else if (rank .eq. dest) then
    tag    = MPI_ANY_TAG
    count  = 10
    from   = MPI_ANY_SOURCE
    call MPI_RECV(data, count, MPI_DOUBLE_PRECISION, from,
+               tag, MPI_COMM_WORLD, status, ierr )
```

Simple Fortran example (cont.)

```
      call MPI_GET_COUNT( status, MPI_DOUBLE_PRECISION,
+                          st_count, ierr )
      st_source = status(MPI_SOURCE)
      st_tag    = status(MPI_TAG)
C
      print *, 'Status info: source = ', st_source,
+          ' tag = ', st_tag, ' count = ', st_count
      print *, rank, ' received', (data(i),i=1,10)
    endif

    call MPI_FINALIZE( ierr )
  end
```

Six Function MPI

MPI is very simple. These six functions allow you to write many programs:

MPI_Init

MPI_Finalize

MPI_Comm_size

MPI_Comm_rank

MPI_Send

MPI_Recv

A taste of things to come

The following examples show a C and Fortran version of the same program.

This program computes PI (with a very simple method) but does not use MPI_Send and MPI_Recv. Instead, it uses *collective* operations to send data to and from all of the running processes. This gives a *different* six-function MPI set:

MPI_Init

MPI_Finalize

MPI_Comm_size

MPI_Comm_rank

MPI_Bcast

MPI_Reduce

Broadcast and Reduction

The routine `MPI_Bcast` sends data from one process to all others.

The routine `MPI_Reduce` combines data from all processes (by adding them in this case), and returning the result to a single process.

Fortran example: PI

```
program main

include "mpif.h"

double precision  PI25DT
parameter        (PI25DT = 3.141592653589793238462643d0)

double precision  mypi, pi, h, sum, x, f, a
integer n, myid, numprocs, i, rc
c                function to integrate
f(a) = 4.d0 / (1.d0 + a*a)

call MPI_INIT( ierr )
call MPI_COMM_RANK( MPI_COMM_WORLD, myid, ierr )
call MPI_COMM_SIZE( MPI_COMM_WORLD, numprocs, ierr )

10  if ( myid .eq. 0 ) then
      write(6,98)
98   format('Enter the number of intervals: (0 quits)')
      read(5,99) n
99   format(i10)
endif

call MPI_BCAST(n,1,MPI_INTEGER,0,MPI_COMM_WORLD,ierr)
```

Fortran example (cont.)

```
c          check for quit signal
  if ( n .le. 0 ) goto 30

c          calculate the interval size
  h = 1.0d0/n

  sum = 0.0d0
  do 20 i = myid+1, n, numprocs
    x  = h * (db1e(i) - 0.5d0)
    sum = sum + f(x)
20  continue
  mypi = h * sum

c          collect all the partial sums
  call MPI_REDUCE(mypi,pi,1,MPI_DOUBLE_PRECISION,MPI_SUM,0,
$   MPI_COMM_WORLD,ierr)

c          node 0 prints the answer.
  if (myid .eq. 0) then
    write(6, 97) pi, abs(pi - PI25DT)
97   format(' pi is approximately: ', F18.16,
+         ' Error is: ', F18.16)
    endif

  goto 10

30  call MPI_FINALIZE(rc)
    stop
    end
```

C example: PI

```
#include "mpi.h"
#include <math.h>

int main(argc,argv)
int argc;
char *argv[];
{
    int done = 0, n, myid, numprocs, i, rc;
    double PI25DT = 3.141592653589793238462643;
    double mypi, pi, h, sum, x, a;

    MPI_Init(&argc,&argv);
    MPI_Comm_size(MPI_COMM_WORLD,&numprocs);
    MPI_Comm_rank(MPI_COMM_WORLD,&myid);
```

C example (cont.)

```
while (!done)
{
    if (myid == 0) {
        printf("Enter the number of intervals: (0 quits) ");
        scanf("%d",&n);
    }
    MPI_Bcast(&n, 1, MPI_INT, 0, MPI_COMM_WORLD);
    if (n == 0) break;

    h = 1.0 / (double) n;
    sum = 0.0;
    for (i = myid + 1; i <= n; i += numprocs) {
        x = h * ((double)i - 0.5);
        sum += 4.0 / (1.0 + x*x);
    }
    mypi = h * sum;

    MPI_Reduce(&mypi, &pi, 1, MPI_DOUBLE, MPI_SUM, 0,
              MPI_COMM_WORLD);

    if (myid == 0)
        printf("pi is approximately %.16f, Error is %.16f\n",
              pi, fabs(pi - PI25DT));
}
MPI_Finalize();
}
```

Exercise - PI

Objective: Experiment with send/receive

Run either program for PI. Write new versions that replace the calls to `MPI_Bcast` and `MPI_Reduce` with `MPI_Send` and `MPI_Recv`.

⚠ *The MPI broadcast and reduce operations use at most $\log p$ send and receive operations on each process where p is the size of `MPI_COMM_WORLD`. How many operations do your versions use?*

Exercise - Ring

Objective: Experiment with send/receive

Write a program to send a message around a ring of processors. That is, processor 0 sends to processor 1, who sends to processor 2, etc. The last processor returns the message to processor 0.

⚠ *You can use the routine `MPI_Wtime` to time code in MPI. The statement*

```
t = MPI_Wtime();
```

returns the time as a double (DOUBLE PRECISION in Fortran).

Topologies

MPI provides routines to provide structure to collections of processes

This helps to answer the question:

Who are my neighbors?

Cartesian Topologies

A Cartesian topology is a mesh

Example of 3×4 Cartesian mesh with arrows pointing at the *right* neighbors:

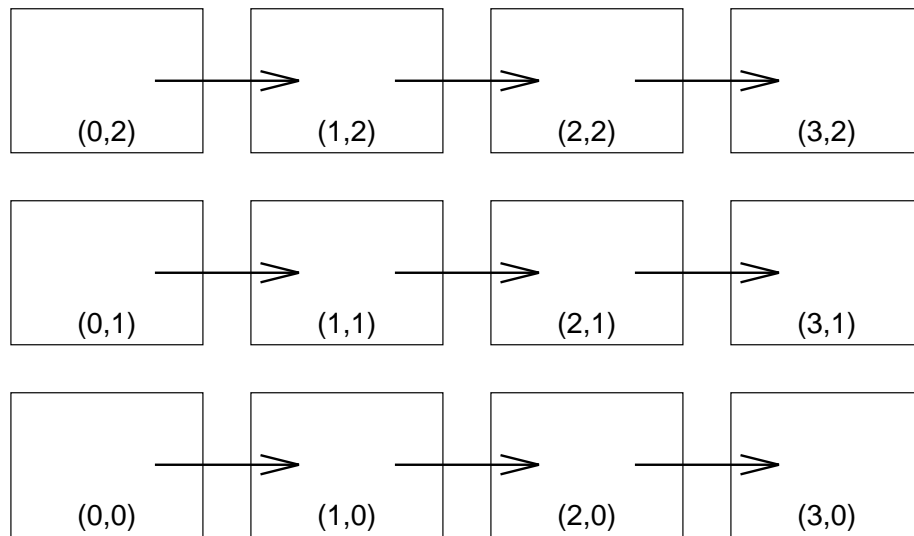

Defining a Cartesian Topology

The routine `MPI_Cart_create` creates a Cartesian decomposition of the processes, with the number of dimensions given by the `ndim` argument.

```
dims(1)      = 4
dims(2)      = 3
periods(1)   = .false.
periods(2)   = .false.
reorder      = .true.
ndim         = 2
call MPI_CART_CREATE( MPI_COMM_WORLD, ndim, dims,
$                      periods, reorder, comm2d, ierr )
```

Finding neighbors

`MPI_Cart_create` creates a new *communicator* with the same processes as the input communicator, but with the specified topology.

The question, Who are my neighbors, can now be answered with `MPI_Cart_shift`:

```
call MPI_CART_SHIFT( comm2d, 0, 1,  
                    nbrleft, nbrright, ierr )  
call MPI_CART_SHIFT( comm2d, 1, 1,  
                    nbrbottom, nbrtop, ierr )
```

The values returned are the ranks, in the communicator `comm2d`, of the neighbors shifted by ± 1 in the two dimensions.

Who am I?

Can be answered with

```
integer coords(2)
call MPI_COMM_RANK( comm1d, myrank, ierr )
call MPI_CART_COORDS( comm1d, myrank, 2,
$                      coords, ierr )
```

Returns the Cartesian coordinates of the calling process in `coords`.

Partitioning

When creating a Cartesian topology, one question is “What is a good choice for the decomposition of the processors?”

This question can be answered with `MPI_Dims_create`:

```
integer dims(2)
dims(1) = 0
dims(2) = 0
call MPI_COMM_SIZE( MPI_COMM_WORLD, size, ierr )
call MPI_DIMS_CREATE( size, 2, dims, ierr )
```

Other Topology Routines

MPI contains routines to translate between Cartesian coordinates and ranks in a communicator, and to access the properties of a Cartesian topology.

The routine `MPI_Graph_create` allows the creation of a general graph topology.

Why are these routines in MPI?

In many parallel computer interconnects, some processors are closer to than others. These routines allow the MPI implementation to provide an ordering of processes in a topology that makes logical neighbors close in the physical interconnect.

⚠ *Some parallel programmers may remember hypercubes and the effort that went into assigning nodes in a mesh to processors in a hypercube through the use of Grey codes. Many new systems have different interconnects; ones with multiple paths may have notions of near neighbors that changes with time. These routines free the programmer from many of these considerations. The `reorder` argument is used to request the best ordering.*

The periods argument

Who are my neighbors if I am at the edge of a Cartesian Mesh?

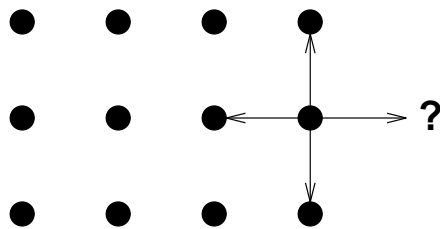

Periodic Grids

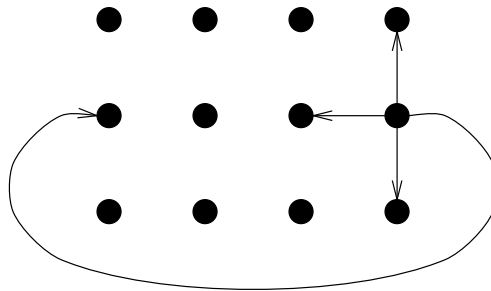

Specify this in `MPI_Cart_create` with

```
dims(1)      = 4
dims(2)      = 3
periods(1)   = .TRUE.
periods(2)   = .TRUE.
reorder      = .true.
ndim         = 2
call MPI_CART_CREATE( MPI_COMM_WORLD, ndim, dims,
$                      periods, reorder, comm2d, ierr )
```

Nonperiodic Grids

In the nonperiodic case, a neighbor may not exist. This is indicated by a rank of `MPI_PROC_NULL`.

This rank *may be used* in send and receive calls in MPI. The action in both cases is as if the call was not made.

Collective Communications in MPI

- Communication is coordinated among a group of processes.
- Groups can be constructed “by hand” with MPI group-manipulation routines or by using MPI topology-definition routines.
- Message tags are not used. Different communicators are used instead.
- No non-blocking collective operations.
- Three classes of collective operations:
 - synchronization
 - data movement
 - collective computation

Synchronization

- `MPI_Barrier(comm)`
- Function blocks until all processes in `comm` call it.

Available Collective Patterns

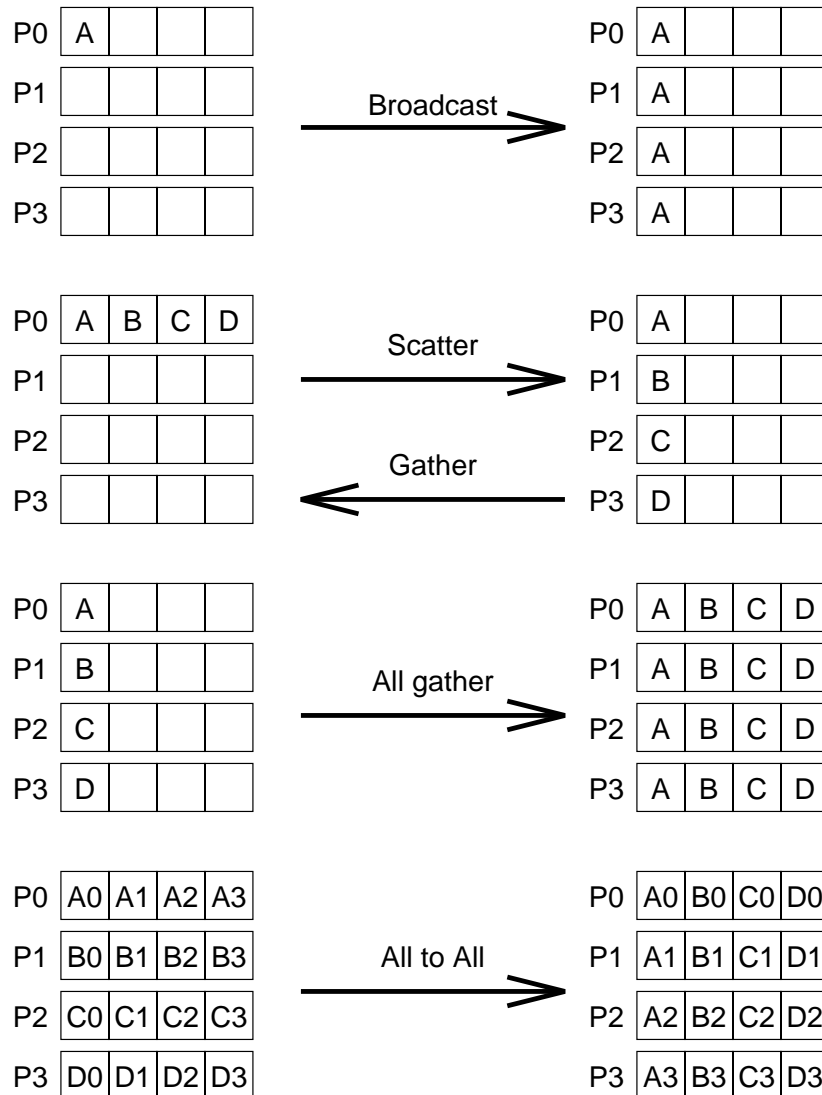

Schematic representation of collective data movement in MPI

Available Collective Computation Patterns

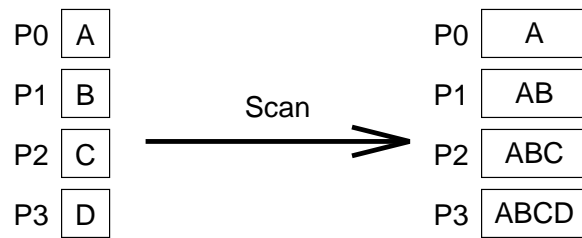
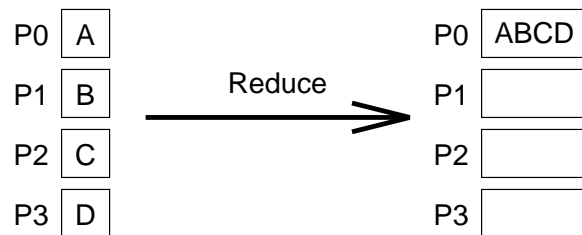

Schematic representation of collective data movement in MPI

MPI Collective Routines

- Many routines:

Allgather	Allgatherv	Allreduce
Alltoall	Alltoallv	Bcast
Gather	Gatherv	Reduce
ReduceScatter	Scan	Scatter
Scatterv		

- All versions deliver results to all participating processes.
- V versions allow the chunks to have different sizes.
- Allreduce, Reduce, ReduceScatter, and Scan take both built-in and user-defined combination functions.

Built-in Collective Computation Operations

MPI Name	Operation
MPI_MAX	Maximum
MPI_MIN	Minimum
MPI_PROD	Product
MPI_SUM	Sum
MPI_LAND	Logical and
MPI_LOR	Logical or
MPI_LXOR	Logical exclusive or (xor)
MPI_BAND	Bitwise and
MPI_BOR	Bitwise or
MPI_BXOR	Bitwise xor
MPI_MAXLOC	Maximum value and location
MPI_MINLOC	Minimum value and location

Defining Your Own Collective Operations

```
MPI_Op_create(user_function, commute, op)
MPI_Op_free(op)
```

```
user_function(invec, inoutvec, len, datatype)
```

The user function should perform

```
inoutvec[i] = invec[i] op inoutvec[i];
```

for i from 0 to $len-1$.

`user_function` can be non-commutative (e.g., matrix multiply).

Sample user function

For example, to create an operation that has the same effect as `MPI_SUM` on Fortran double precision values, use

```
subroutine myfunc( invec, inoutvec, len, datatype )
  integer len, datatype
  double precision invec(len), inoutvec(len)
  integer i
  do 10 i=1,len
10   inoutvec(i) = invec(i) + inoutvec(i)
  return
end
```

To use, just

```
integer myop
call MPI_Op_create( myfunc, .true., myop, ierr )
call MPI_Reduce( a, b, 1, MPI_DOUBLE_PRECISION, myop, ... )
```

The routine `MPI_Op_free` destroys user-functions when they are no longer needed.

Defining groups

All MPI communication is relative to a *communicator* which contains a *context* and a *group*. The group is just a set of processes.

Subdividing a communicator

The easiest way to create communicators with new groups is with `MPI_COMM_SPLIT`.

For example, to form groups of rows of processes

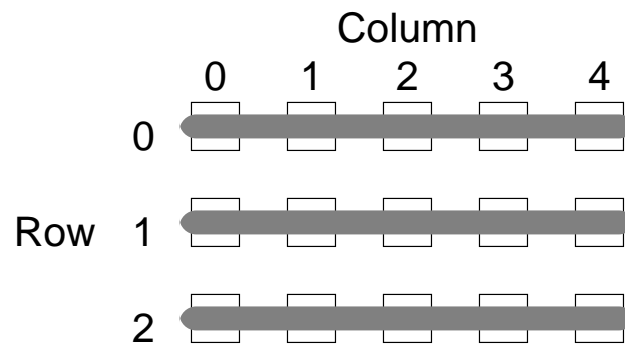

use

```
MPI_Comm_split( oldcomm, row, 0, &newcomm );
```

To maintain the order by rank, use

```
MPI_Comm_rank( oldcomm, &rank );  
MPI_Comm_split( oldcomm, row, rank, &newcomm );
```

Subdividing (con't)

Similarly, to form groups of columns,

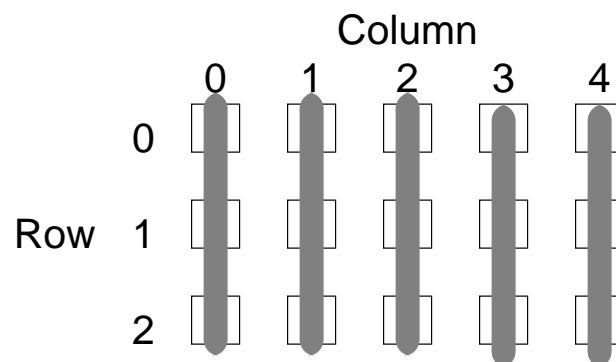

use

```
MPI_Comm_split( oldcomm, column, 0, &newcomm2 );
```

To maintain the order by rank, use

```
MPI_Comm_rank( oldcomm, &rank );  
MPI_Comm_split( oldcomm, column, rank, &newcomm2 );
```

Manipulating Groups

Another way to create a communicator with specific members is to use `MPI_Comm_create`.

```
MPI_Comm_create( oldcomm, group, &newcomm );
```

The group can be created in many ways:

Creating Groups

All group creation routines create a group by specifying the members to take from an existing group.

- `MPI_Group_incl` specifies specific members
- `MPI_Group_excl` excludes specific members
- `MPI_Group_range_incl` and `MPI_Group_range_excl` use ranges of members
- `MPI_Group_union` and `MPI_Group_intersection` creates a new group from two existing groups.

To get an existing group, use

```
MPI_Comm_group( oldcomm, &group );
```

Free a group with

```
MPI_Group_free( &group );
```

Buffering issues

Where does data go when you send it? One possibility is:

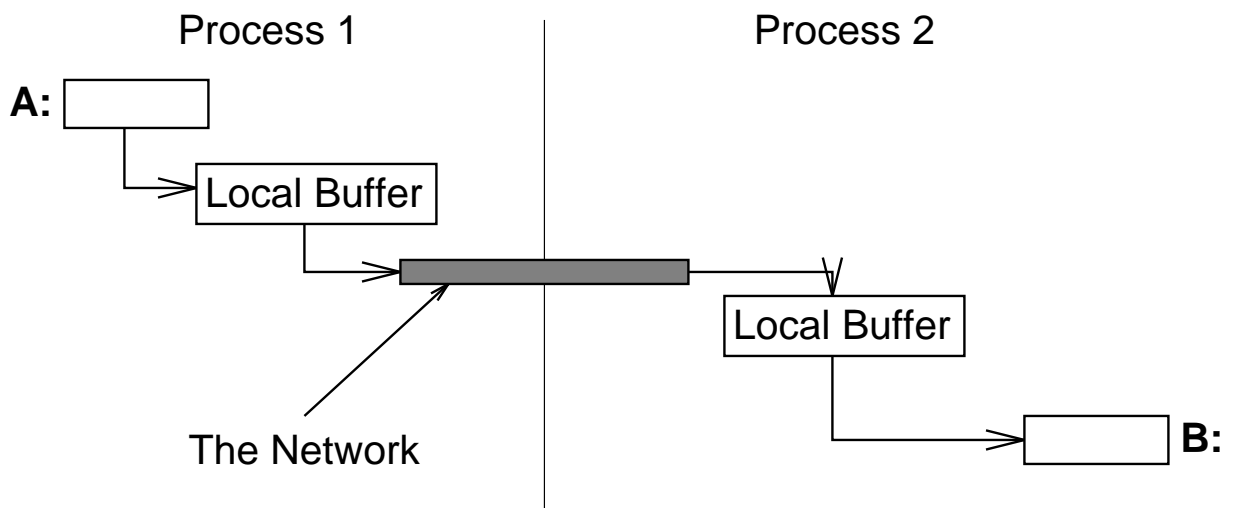

Better buffering

This is not very efficient. There are three copies in addition to the exchange of data between processes. We prefer

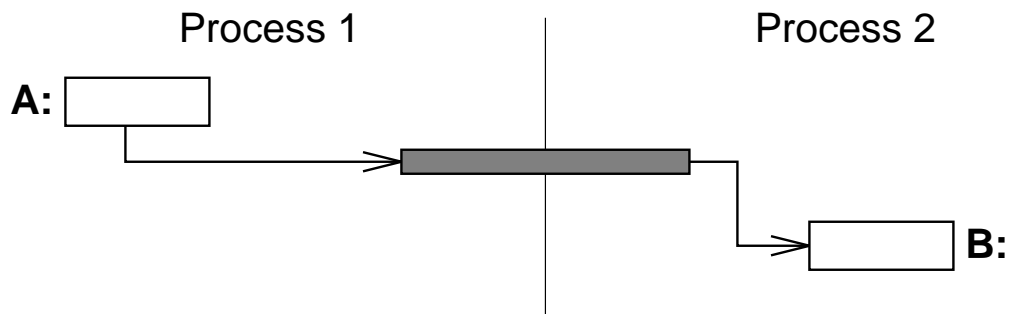

But this requires that either that `MPI_Send` not return until the data has been delivered *or* that we allow a send operation to return before completing the transfer. In this case, we need to test for completion later.

Blocking and Non-Blocking communication

- So far we have used **blocking** communication:
 - `MPI_Send` does not complete until buffer is empty (available for reuse).
 - `MPI_Recv` does not complete until buffer is full (available for use).
- Simple, but can be “unsafe”:

Process 0	Process 1
<code>Send(1)</code>	<code>Send(0)</code>
<code>Recv(1)</code>	<code>Recv(0)</code>

Completion depends in general on size of message and amount of system buffering.

 *Send works for small enough messages but fails when messages get too large. Too large ranges from zero bytes to 100's of Megabytes.*

Some Solutions to the “Unsafe” Problem

- Order the operations more carefully:

Process 0	Process 1
Send(1)	Recv(0)
Recv(1)	Send(0)

- Supply receive buffer at same time as send, with MPI_Sendrecv:

Process 0	Process 1
Sendrecv(1)	Sendrecv(0)

- Use non-blocking operations:

Process 0	Process 1
Isend(1)	Isend(0)
Irecv(1)	Irecv(0)
Waitall	Waitall

- Use MPI_Bsend

MPI's Non-Blocking Operations

Non-blocking operations return (immediately)
“request handles” that can be waited on and queried:

- `MPI_Isend(start, count, datatype, dest, tag, comm, request)`
- `MPI_Irecv(start, count, datatype, dest, tag, comm, request)`
- `MPI_Wait(request, status)`

One can also test without waiting: `MPI_Test(request, flag, status)`

Multiple completions

It is often desirable to wait on multiple requests. An example is a master/slave program, where the master waits for one or more slaves to send it a message.

- `MPI_Waitall(count, array_of_requests, array_of_statuses)`
- `MPI_Waitany(count, array_of_requests, index, status)`
- `MPI_Waitsome(incount, array_of_requests, outcount, array_of_indices, array_of_statuses)`

There are corresponding versions of test for each of these.

 *The `MPI_WAITSSOME` and `MPI_TESTSSOME` may be used to implement master/slave algorithms that provide fair access to the master by the slaves.*

Fairness

What happens with this program:

```
#include "mpi.h"
#include <stdio.h>
int main(argc, argv)
int argc;
char **argv;
{
int rank, size, i, buf[1];
MPI_Status status;

MPI_Init( &argc, &argv );
MPI_Comm_rank( MPI_COMM_WORLD, &rank );
MPI_Comm_size( MPI_COMM_WORLD, &size );
if (rank == 0) {
    for (i=0; i<100*(size-1); i++) {
        MPI_Recv( buf, 1, MPI_INT, MPI_ANY_SOURCE,
                 MPI_ANY_TAG, MPI_COMM_WORLD, &status );
        printf( "Msg from %d with tag %d\n",
                status.MPI_SOURCE, status.MPI_TAG );
    }
}
else {
    for (i=0; i<100; i++)
        MPI_Send( buf, 1, MPI_INT, 0, i, MPI_COMM_WORLD );
}
MPI_Finalize();
return 0;
}
```

Fairness in message-passing

An parallel algorithm is *fair* if no process is effectively ignored. In the preceeding program, processes with low rank (like process zero) may be the only one whose messages are received.

MPI makes no guarentees about fairness. However, MPI makes it possible to write efficient, fair programs.

Providing Fairness

One alternative is

```
#define large 128
MPI_Request requests[large];
MPI_Status  statuses[large];
int         indices[large];
int         buf[large];
for (i=1; i<size; i++)
    MPI_Irecv( buf+i, 1, MPI_INT, i,
               MPI_ANY_TAG, MPI_COMM_WORLD, &requests[i-1] );
while(not done) {
    MPI_Waitsome( size-1, requests, &ndone, indices, statuses );
    for (i=0; i<ndone; i++) {
        j = indices[i];
        printf( "Msg from %d with tag %d\n",
                statuses[i].MPI_SOURCE,
                statuses[i].MPI_TAG );
        MPI_Irecv( buf+j, 1, MPI_INT, j,
                   MPI_ANY_TAG, MPI_COMM_WORLD, &requests[j] );
    }
}
```

Providing Fairness (Fortran)

One alternative is

```
parameter( large = 128 )
integer requests(large);
integer statuses(MPI_STATUS_SIZE,large);
integer indices(large);
integer buf(large);
logical done
do 10 i = 1,size-1
10 call MPI_Irecv( buf(i), 1, MPI_INTEGER, i,
*           MPI_ANY_TAG, MPI_COMM_WORLD, requests(i), ierr )
20 if (.not. done) then
    call MPI_Waitsome( size-1, requests, ndone,
                    indices, statuses, ierr )
    do 30 i=1, ndone
        j = indices(i)
        print *, 'Msg from ', statuses(MPI_SOURCE,i), ' with tag',
*           statuses(MPI_TAG,i)
        call MPI_Irecv( buf(j), 1, MPI_INTEGER, j,
                    MPI_ANY_TAG, MPI_COMM_WORLD, requests(j), ierr )
        done = ...
30 continue
    goto 20
endif
```

Exercise - Fairness

Objective: Use nonblocking communications
Complete the program fragment on
“providing fairness”. Make sure that you
leave no uncompleted requests. How would
you test your program?

More on nonblocking communication

In applications where the time to send data between processes is large, it is often helpful to cause communication and computation to overlap. This can easily be done with MPI's non-blocking routines.

For example, in a 2-D finite difference mesh, moving data needed for the boundaries can be done at the same time as computation on the interior.

```
MPI_Irecv( ... each ghost edge ... );
MPI_Isend( ... data for each ghost edge ... );
... compute on interior
while (still some uncompleted requests) {
    MPI_Waitany( ... requests ... )
    if (request is a receive)
        ... compute on that edge ...
}
```

Note that we call `MPI_Waitany` several times. This exploits the fact that after a request is satisfied, it is set to `MPI_REQUEST_NULL`, and that this is a valid request object to the wait and test routines.

Communication Modes

MPI provides multiple *modes* for sending messages:

- Synchronous mode (`MPI_Ssend`): the send does not complete until a matching receive has begun. (Unsafe programs become incorrect and usually deadlock within an `MPI_Ssend`.)
- Buffered mode (`MPI_Bsend`): the user supplies the buffer to system for its use. (User supplies enough memory to make unsafe program safe).
- Ready mode (`MPI_Rsend`): user guarantees that matching receive has been posted.
 - allows access to fast protocols
 - undefined behavior if the matching receive is not posted

Non-blocking versions:

`MPI_Issend`, `MPI_Irsend`, `MPI_Ibsend`

Note that an `MPI_Recv` may receive messages sent with *any* send mode.

Buffered Send

MPI provides a send routine that may be used when `MPI_Isend` is awkward to use (e.g., lots of small messages).

`MPI_Bsend` makes use of a *user-provided* buffer to save any messages that can not be immediately sent.

```
int  bufsize;
char *buf = malloc(bufsize);
MPI_Buffer_attach( buf, bufsize );
...
MPI_Bsend( ... same as MPI_Send ... );
...
MPI_Buffer_detach( &buf, &bufsize );
```

The `MPI_Buffer_detach` call does not complete until all messages are sent.

 *The performance of `MPI_Bsend` depends on the implementation of MPI and may also depend on the size of the message. For example, making a message one byte longer may cause a significant drop in performance.*

Reusing the same buffer

Consider a loop

```
MPI_Buffer_attach( buf, bufsize );
while (!done) {
    ...
    MPI_Bsend( ... );
}
```

where the `buf` is large enough to hold the message in the `MPI_Bsend`. This code may *fail* because the

```
{
void *buf; int bufsize;
MPI_Buffer_detach( &buf, &bufsize );
MPI_Buffer_attach( buf, bufsize );
}
```

Other Point-to-Point Features

- `MPI_SENDRECV`, `MPI_SENDRECV_REPLACE`
- `MPI_CANCEL`
- Persistent communication requests

Datatypes and Heterogeneity

MPI datatypes have two main purposes

- Heterogeneity — parallel programs between different processors
- Noncontiguous data — structures, vectors with non-unit stride, etc.

Basic datatype, corresponding to the underlying language, are predefined.

The user can construct new datatypes at run time; these are called *derived datatypes*.

Datatypes in MPI

Elementary: Language-defined types (e.g.,
MPI_INT or MPI_DOUBLE_PRECISION)

Vector: Separated by constant “stride”

Contiguous: Vector with stride of one

Hvector: Vector, with stride in bytes

Indexed: Array of indices (for
scatter/gather)

Hindexed: Indexed, with indices in bytes

Struct: General mixed types (for C structs
etc.)

Basic Datatypes (Fortran)

MPI datatype	Fortran datatype
MPI_INTEGER	INTEGER
MPI_REAL	REAL
MPI_DOUBLE_PRECISION	DOUBLE PRECISION
MPI_COMPLEX	COMPLEX
MPI_LOGICAL	LOGICAL
MPI_CHARACTER	CHARACTER(1)
MPI_BYTE	
MPI_PACKED	

Basic Datatypes (C)

MPI datatype	C datatype
MPI_CHAR	signed char
MPI_SHORT	signed short int
MPI_INT	signed int
MPI_LONG	signed long int
MPI_UNSIGNED_CHAR	unsigned char
MPI_UNSIGNED_SHORT	unsigned short int
MPI_UNSIGNED	unsigned int
MPI_UNSIGNED_LONG	unsigned long int
MPI_FLOAT	float
MPI_DOUBLE	double
MPI_LONG_DOUBLE	long double
MPI_BYTE	
MPI_PACKED	

Vectors

29	30	31	32	33	34	35
22	23	24	25	26	27	28
15	16	17	18	19	20	21
8	9	10	11	12	13	14
1	2	3	4	5	6	7

To specify this row (in C order), we can use

```
MPI_Type_vector( count, blocklen, stride, oldtype,  
                &newtype );  
MPI_Type_commit( &newtype );
```

The exact code for this is

```
MPI_Type_vector( 5, 1, 7, MPI_DOUBLE, &newtype );  
MPI_Type_commit( &newtype );
```

Structures

Structures are described by arrays of

- number of elements (`array_of_len`)
- displacement or location (`array_of_displs`)
- datatype (`array_of_types`)

```
MPI_Type_structure( count, array_of_len,  
                   array_of_displs,  
                   array_of_types, &newtype );
```

Example: Structures

```
struct {
    char    display[50];    /* Name of display */
    int     maxiter;       /* max # of iterations */
    double  xmin, ymin;    /* lower left corner of rectangle */
    double  xmax, ymax;    /* upper right corner */
    int     width;        /* of display in pixels */
    int     height;       /* of display in pixels */
} cmdline;

/* set up 4 blocks */
int     blockcounts[4] = {50,1,4,2};
MPI_Datatype types[4];
MPI_Aint  displs[4];
MPI_Datatype cmdtype;

/* initialize types and displs with addresses of items */
MPI_Address( &cmdline.display, &displs[0] );
MPI_Address( &cmdline.maxiter, &displs[1] );
MPI_Address( &cmdline.xmin, &displs[2] );
MPI_Address( &cmdline.width, &displs[3] );
types[0] = MPI_CHAR;
types[1] = MPI_INT;
types[2] = MPI_DOUBLE;
types[3] = MPI_INT;
for (i = 3; i >= 0; i--)
    displs[i] -= displs[0];
MPI_Type_struct( 4, blockcounts, displs, types, &cmdtype );
MPI_Type_commit( &cmdtype );
```

Strides

The extent of a datatype is (normally) the distance between the first and last member.

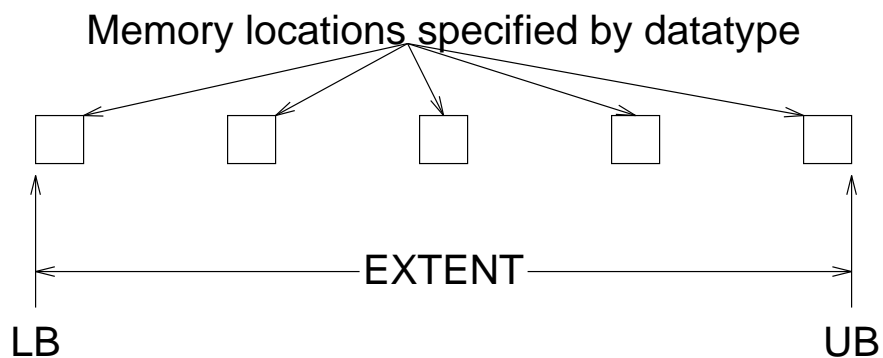

You can set an artificial extent by using `MPI_UB` and `MPI_LB` in `MPI_Type_struct`.

Vectors revisited

This code creates a datatype for an arbitrary number of element in a row of an array stored in Fortran order (column first).

```
int blens[2], displs[2];
MPI_Datatype types[2], rowtype;
blens[0] = 1;
blens[1] = 1;
displs[0] = 0;
displs[1] = number_in_column * sizeof(double);
types[0] = MPI_DOUBLE;
types[1] = MPI_UB;
MPI_Type_struct( 2, blens, displs, types, &rowtype );
MPI_Type_commit( &rowtype );
```

To send n elements, you can use

```
MPI_Send( buf, n, rowtype, ... );
```

Structures revisited

When sending an array of a structure, it is important to ensure that MPI and the C compiler have the same value for the size of each structure. The most portable way to do this is to add an MPI_UB to the structure definition for the end of the structure. In the previous example, this is

```
/* initialize types and displs with addresses of items */
MPI_Address( &cmdline.display, &displs[0] );
MPI_Address( &cmdline.maxiter, &displs[1] );
MPI_Address( &cmdline.xmin,    &displs[2] );
MPI_Address( &cmdline.width,   &displs[3] );
MPI_Address( &cmdline+1,      &displs[4] );
types[0] = MPI_CHAR;
types[1] = MPI_INT;
types[2] = MPI_DOUBLE;
types[3] = MPI_INT;
types[4] = MPI_UB;
for (i = 4; i >= 0; i--)
    displs[i] -= displs[0];
MPI_Type_struct( 5, blockcounts, displs, types, &cmdtype );
MPI_Type_commit( &cmdtype );
```

Interleaving data

By moving the UB inside the data, you can interleave data.

Consider the matrix

0	8	16	24	32
1	9	17	25	33
2	10	18	26	34
3	11	19	27	35
4	12	20	28	36
5	13	21	29	37
6	14	22	30	38
7	15	23	31	39

We wish to send 0-3,8-11,16-19, and 24-27 to process 0, 4-7,12-15,20-23, and 28-31 to process 1, etc. How can we do this with `MPI_Scatterv`?

An interleaved datatype

```
MPI_Type_vector( 4, 4, 8, MPI_DOUBLE, &vec );
```

defines a block of this matrix.

```
blens[0] = 1;    blens[1] = 1;
types[0] = vec; types[1] = MPI_UB;
displs[0] = 0;   displs[1] = sizeof(double);
MPI_Type_struct( 2, blens, displs, types, &block );
```

defines a block whose extent is just 1 entries.

Scattering a Matrix

We set the displacements for each block as the location of the first element in the block. This works because `MPI_Scatterv` uses the extents to determine the start of each piece to send.

```
sdispls[0] = 0;
sdispls[1] = 4;
sdispls[2] = 32;
sdispls[3] = 36;
MPI_Scatterv( sendbuf, sendcounts, sdispls, block,
              recvbuf, nx * ny, MPI_DOUBLE, 0,
              MPI_COMM_WORLD );
```

 *How would use use the topology routines to make this more general?*

Exercises - datatypes

Objective: Learn about datatypes

1. Write a program to send rows of a matrix (stored in column-major form) to the other processors.

Let processor 0 have the entire matrix, which has as many rows as processors.

Processor 0 sends row i to processor i .

Processor i reads that row into a local array that holds only that row. That is, processor 0 has a matrix $A(N, M)$ while the other processors have a row $B(M)$.

- (a) Write the program to handle the case where the matrix is square.
- (b) Write the program to handle a number of columns read from the terminal.

C programmers may send columns of a matrix stored in row-major form if they prefer.

If you have time, try one of the following. If you don't have time, think about how you would program these.

2. Write a program to transpose a matrix, where each processor has a part of the matrix. Use topologies to define a 2-Dimensional partitioning

of the matrix across the processors, and assume that all processors have the same size submatrix.

- (a) Use `MPI_Send` and `MPI_Recv` to send the block, the transpose the block.
 - (b) Use `MPI_Sendrecv` instead.
 - (c) Create a datatype that allows you to receive the block already transposed.
3. Write a program to send the "ghostpoints" of a 2-Dimensional mesh to the neighboring processors. Assume that each processor has the same size subblock.
- (a) Use topologies to find the neighbors
 - (b) Define a datatype for the "rows"
 - (c) Use `MPI_Sendrecv` or `MPI_IRecv` and `MPI_Send` with `MPI_Waitall`.
 - (d) Use `MPI_Isend` and `MPI_Irecv` to start the communication, do some computation on the interior, and then use `MPI_Waitany` to process the boundaries as they arrive

The same approach works for general datastructures, such as unstructured meshes.

4. Do 3, but for 3-Dimensional meshes. You will need `MPI_Type_Hvector`.

Tools for writing libraries

MPI is specifically designed to make it easier to write message-passing libraries

- Communicators solve tag/source wild-card problem
- Attributes provide a way to attach information to a communicator

Private communicators

One of the first thing that a library should normally do is create private communicator. This allows the library to send and receive messages that are known only to the library.

```
MPI_Comm_dup( old_comm, &new_comm );
```

Attributes

Attributes are data that can be attached to one or more communicators.

Attributes are referenced by *keyval*. Keyvals are created with `MPI_KEYVAL_CREATE`.

Attributes are attached to a communicator with `MPI_Attr_put` and their values accessed by `MPI_Attr_get`.

 *Operations are defined for what happens to an attribute when it is copied (by creating one communicator from another) or deleted (by deleting a communicator) when the keyval is created.*

What is an attribute?

In C, an attribute is a pointer of type `void *`. You must allocate storage for the attribute to point to (make sure that you don't use the address of a local variable).

In Fortran, it is a single `INTEGER`.

Examples of using attributes

- Forcing sequential operation
- Managing tags

Sequential Sections

```
#include "mpi.h"
#include <stdlib.h>

static int MPE_Seq_keyval = MPI_KEYVAL_INVALID;

/*@
   MPE_Seq_begin - Begins a sequential section of code.

   Input Parameters:
   . comm - Communicator to sequentialize.
   . ng   - Number in group. This many processes are allowed
to execute
   at the same time. Usually one.

   @*/
void MPE_Seq_begin( comm, ng )
MPI_Comm comm;
int      ng;
{
int      lidx, np;
int      flag;
MPI_Comm local_comm;
MPI_Status status;

/* Get the private communicator for the sequential
operations */
if (MPE_Seq_keyval == MPI_KEYVAL_INVALID) {
    MPI_Keyval_create( MPI_NULL_COPY_FN,
                      MPI_NULL_DELETE_FN,
                      &MPE_Seq_keyval, NULL );
}
}
```

Sequential Sections II

```
MPI_Attr_get( comm, MPE_Seq_keyval, (void *)&local_comm,
              &flag );
if (!flag) {
    /* This expects a communicator to be a pointer */
    MPI_Comm_dup( comm, &local_comm );
    MPI_Attr_put( comm, MPE_Seq_keyval,
                 (void *)&local_comm );
}
MPI_Comm_rank( comm, &lidx );
MPI_Comm_size( comm, &np );
if (lidx != 0) {
    MPI_Recv( NULL, 0, MPI_INT, lidx-1, 0, local_comm,
             &status );
}
/* Send to the next process in the group unless we
   are the last process in the processor set */
if ( (lidx % ng) < ng - 1 && lidx != np - 1) {
    MPI_Send( NULL, 0, MPI_INT, lidx + 1, 0, local_comm );
}
}
```

Sequential Sections III

```
/*@
    MPE_Seq_end - Ends a sequential section of code.
    Input Parameters:
    . comm - Communicator to sequentialize.
    . ng   - Number in group.
*/
void MPE_Seq_end( comm, ng )
MPI_Comm comm;
int      ng;
{
    int      lidx, np, flag;
    MPI_Status status;
    MPI_Comm local_comm;

    MPI_Comm_rank( comm, &lidx );
    MPI_Comm_size( comm, &np );
    MPI_Attr_get( comm, MPE_Seq_keyval, (void *)&local_comm,
    &flag );
    if (!flag)
        MPI_Abort( comm, MPI_ERR_UNKNOWN );
    /* Send to the first process in the next group OR to the
    first process
    in the processor set */
    if ( (lidx % ng) == ng - 1 || lidx == np - 1) {
        MPI_Send( NULL, 0, MPI_INT, (lidx + 1) % np, 0,
    local_comm );
    }
    if (lidx == 0) {
        MPI_Recv( NULL, 0, MPI_INT, np-1, 0, local_comm,
    &status );
    }
}
```

Comments on sequential sections

- Note use of `MPI_KEYVAL_INVALID` to determine to create a keyval
- Note use of flag on `MPI_Attr_get` to discover that a communicator has no attribute for the keyval

Example: Managing tags

Problem: A library contains many objects that need to communicate in ways that are not known until runtime.

Messages between objects are kept separate by using different message tags. How are these tags chosen?

- Unsafe to use compile time values
- Must allocate tag values at runtime

Solution:

Use a private communicator and use an attribute to keep track of available tags in that communicator.

Caching tags on communicator

```
#include "mpi.h"

static int MPE_Tag_keyval = MPI_KEYVAL_INVALID;

/*
   Private routine to delete internal storage when a
   communicator is freed.
*/
int MPE_DelTag( comm, keyval, attr_val, extra_state )
MPI_Comm *comm;
int      *keyval;
void     *attr_val, *extra_state;
{
free( attr_val );
return MPI_SUCCESS;
}
```

Caching tags on communicator II

```
/*@
  MPE_GetTags - Returns tags that can be used in
  communication with a
  communicator

  Input Parameters:
  . comm_in - Input communicator
  . ntags   - Number of tags

  Output Parameters:
  . comm_out - Output communicator. May be 'comm_in'.
  . first_tag - First tag available
  @*/
int MPE_GetTags( comm_in, ntags, comm_out, first_tag )
MPI_Comm comm_in, *comm_out;
int      ntags, *first_tag;
{
int mpe_errno = MPI_SUCCESS;
int tagval, *tagvalp, *maxval, flag;

if (MPE_Tag_keyval == MPI_KEYVAL_INVALID) {
  MPI_Keyval_create( MPI_NULL_COPY_FN, MPE_DelTag,
                    &MPE_Tag_keyval, (void *)0 );
}
```

Caching tags on communicator III

```
if (mpe_errno = MPI_Attr_get( comm_in, MPE_Tag_keyval,
&tagvalp, &flag ))
    return mpe_errno;

if (!flag) {
    /* This communicator is not yet known to this system,
so we
        dup it and setup the first value */
    MPI_Comm_dup( comm_in, comm_out );
    comm_in = *comm_out;
    MPI_Attr_get( MPI_COMM_WORLD, MPI_TAG_UB, &maxval,
&flag );
    tagvalp = (int *)malloc( 2 * sizeof(int) );
    printf( "Mallocing address %x\n", tagvalp );
    if (!tagvalp) return MPI_ERR_EXHAUSTED;
    tagvalp = *maxval;
    MPI_Attr_put( comm_in, MPE_Tag_keyval, tagvalp );
    return MPI_SUCCESS;
}
```

Caching tags on communicator IV

```
*comm_out = comm_in;
if (*tagvalp < ntags) {
    /* Error, out of tags.  Another solution would be to do
       an MPI_Comm_dup. */
    return MPI_ERR_INTERN;
}
*first_tag = *tagvalp - ntags;
*tagvalp   = *first_tag;

return MPI_SUCCESS;
}
```

Caching tags on communicator V

```
/*@
  MPE_ReturnTags - Returns tags allocated with MPE_GetTags.

  Input Parameters:
  . comm - Communicator to return tags to
  . first_tag - First of the tags to return
  . ntags - Number of tags to return.
  @*/
int MPE_ReturnTags( comm, first_tag, ntags )
MPI_Comm comm;
int      first_tag, ntags;
{
int *tagvalp, flag, mpe_errno;

if (mpe_errno = MPI_Attr_get( comm, MPE_Tag_keyval,
&tagvalp, &flag ))
    return mpe_errno;

if (!flag) {
    /* Error, attribute does not exist in this communicator
    */
    return MPI_ERR_OTHER;
}
if (*tagvalp == first_tag)
    *tagvalp = first_tag + ntags;

return MPI_SUCCESS;
}
```

Caching tags on communicator VI

```
/*@
  MPE_TagsEnd - Returns the private keyval.
  @*/
int MPE_TagsEnd()
{
  MPI_Keyval_free( &MPE_Tag_keyval );
  MPE_Tag_keyval = MPI_KEYVAL_INVALID;
}
```

Commentary

- Use `MPI_KEYVAL_INVALID` to detect when keyval must be created
- Use `flag` return from `MPI_ATTR_GET` to detect when a communicator needs to be initialized

Exercise - Writing libraries

Objective: Use private communicators and attributes

Write a routine to circulate data to the next process, using a nonblocking send and receive operation.

```
void Init_pipe( comm )
void ISend_pipe( comm, bufin, len, datatype, bufout )
void Wait_pipe( comm )
```

A typical use is

```
Init_pipe( MPI_COMM_WORLD )
for (i=0; i<n; i++) {
    ISend_pipe( comm, bufin, len, datatype, bufout );
    Do_Work( bufin, len );
    Wait_pipe( comm );
    t = bufin; bufin = bufout; bufout = t;
}
```

What happens if Do_Work calls MPI routines?

 *What do you need to do to clean up Init_pipe?*

 *How can you use a user-defined topology to determine the next process? (Hint: see MPI_Topo_test and MPI_Cartdim_get.)*

MPI Objects

⚠ *MPI has a variety of objects (communicators, groups, datatypes, etc.) that can be created and destroyed. This section discusses the types of these data and how MPI manages them.*

⚠ *This entire chapter may be skipped by beginners.*

The MPI Objects

`MPI_Request` Handle for nonblocking communication, normally freed by MPI in a test or wait

`MPI_Datatype` MPI datatype. Free with `MPI_Type_free`.

`MPI_Op` User-defined operation. Free with `MPI_Op_free`.

`MPI_Comm` Communicator. Free with `MPI_Comm_free`.

`MPI_Group` Group of processes. Free with `MPI_Group_free`.

`MPI_Errhandler` MPI errorhandler. Free with `MPI_Errhandler_free`.

When should objects be freed?

Consider this code

```
MPI_Type_vector( ly, 1, nx, MPI_DOUBLE, &newx1 );  
MPI_Type_hvector( lz, 1, nx*ny*sizeof(double), newx1,  
                 &newx );  
MPI_Type_commit( &newx );
```

(This creates a datatype for one face of a 3-D decomposition.) When should `newx1` be freed?

Reference counting

MPI keeps track of the use of an MPI object, and only truly destroys it when no-one is using it. `newx1` is being used by the user (the `MPI_Type_vector` that created it) and by the `MPI_Datatype newx` that uses it.

If `newx1` is not needed after `newx` is defined, it should be freed:

```
MPI_Type_vector( ly, 1, nx, MPI_DOUBLE, &newx1 );
MPI_Type_hvector( lz, 1, nx*ny*sizeof(double), newx1,
                 &newx );
MPI_Type_free( &newx1 );
MPI_Type_commit( &newx );
```

Why reference counts

Why not just free the object?

Consider this library routine:

```
void MakeDatatype( nx, ny, ly, lz, MPI_Datatype *new )
{
  MPI_Datatype newx1;
  MPI_Type_vector( ly, 1, nx, MPI_DOUBLE, &newx1 );
  MPI_Type_hvector( lz, 1, nx*ny*sizeof(double), newx1,
                  new );
  MPI_Type_free( &newx1 );
  MPI_Type_commit( new );
}
```

Without the `MPI_Type_free(&newx1)`, it would be very awkward to later free `newx1` when `new` was freed.

Tools for evaluating programs

MPI provides some tools for evaluating the performance of parallel programs.

These are

- Timer
- Profiling interface

The MPI Timer

The elapsed (wall-clock) time between two points in an MPI program can be computed using `MPI_Wtime`:

```
double t1, t2;
t1 = MPI_Wtime();
...
t2 = MPI_Wtime();
printf( "Elapsed time is %f\n", t2 - t1 );
```

The value returned by a single call to `MPI_Wtime` has little value.

 *The times are local; the attribute `MPI_WTIME_IS_GLOBAL` may be used to determine if the times are also synchronized with each other for all processes in `MPI_COMM_WORLD`.*

Profiling

- All routines have two entry points: MPI_... and PMPI_....
- This makes it easy to provide a single level of low-overhead routines to intercept MPI calls without any source code modifications.
- Used to provide “automatic” generation of trace files.

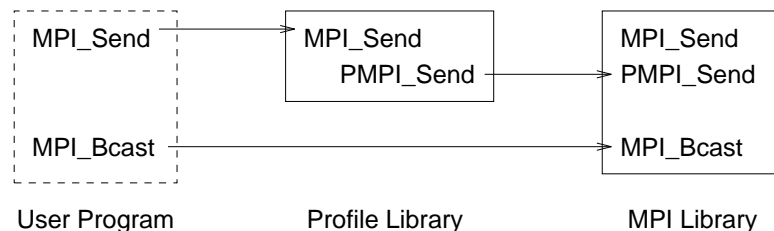

```
static int nsend = 0;
int MPI_Send( start, count, datatype, dest, tag, comm )
{
    nsend++;
    return PMPI_Send( start, count, datatype, dest, tag, comm )
}
```

Writing profiling routines

The MPICH implementation contains a program for writing *wrappers*.

This description will write out each MPI routine that is called.:

```
#ifdef MPI_BUILD_PROFILING
#undef MPI_BUILD_PROFILING
#endif
#include <stdio.h>
#include "mpi.h"

{{fnall fn_name}}
  {{vardecl int llrank}}
  PMPI_Comm_rank( MPI_COMM_WORLD, &llrank );
  printf( "[%d] Starting {{fn_name}}...\n",
llrank ); fflush( stdout );
  {{callfn}}
  printf( "[%d] Ending {{fn_name}}\n", llrank );
fflush( stdout );
{{endfnall}}
```

The command

```
wrappergen -w trace.w -o trace.c
```

converts this to a C program. Then compile the file 'trace.c' and insert the resulting object file into your link line:

```
cc -o a.out a.o ... trace.o -lpmpi -lmpi
```

Another profiling example

This version counts all calls and the number of bytes sent with MPI_Send, MPI_Bsend, or MPI_Isend.

```
#include "mpi.h"

{{foreachfn fn_name MPI_Send MPI_Bsend MPI_Isend}}
static long {{fn_name}}_nbytes_{{fileno}};{{endforeachfn}}

{{forallfn fn_name MPI_Init MPI_Finalize MPI_Wtime}}int
{{fn_name}}_ncalls_{{fileno}};
{{endforallfn}}

{{fnall this_fn_name MPI_Finalize}}
    printf( "{{this_fn_name}} is being called.\n" );

    {{callfn}}

    {{this_fn_name}}_ncalls_{{fileno}}++;
{{endfnall}}

{{fn fn_name MPI_Send MPI_Bsend MPI_Isend}}
    {{vardecl int typesize}}

    {{callfn}}

    MPI_Type_size( {{datatype}}, (MPI_Aint *)&{{typesize}} );
    {{fn_name}}_nbytes_{{fileno}}+={{typesize}}*{{count}}
    {{fn_name}}_ncalls_{{fileno}}++;

{{endfn}}
```

Another profiling example (con't)

```
{{fn fn_name MPI_Finalize}}
  {{forallfn dis_fn}}
    if ({{dis_fn}}_ncalls_{{fileno}}) {
      printf( "{{dis_fn}}: %d calls\n",
              {{dis_fn}}_ncalls_{{fileno}} );
    }
  {{endforallfn}}
  if (MPI_Send_ncalls_{{fileno}}) {
    printf( "%d bytes sent in %d calls with MPI_Send\n",
            MPI_Send_nbytes_{{fileno}},
MPI_Send_ncalls_{{fileno}} );
  }
{{callfn}}
{{endfn}}
```

Generating and viewing log files

Log files that contain a history of a parallel computation can be very valuable in understanding a parallel program. The upshot and nupshot programs, provided in the MPICH and MPI-F implementations, may be used to view log files

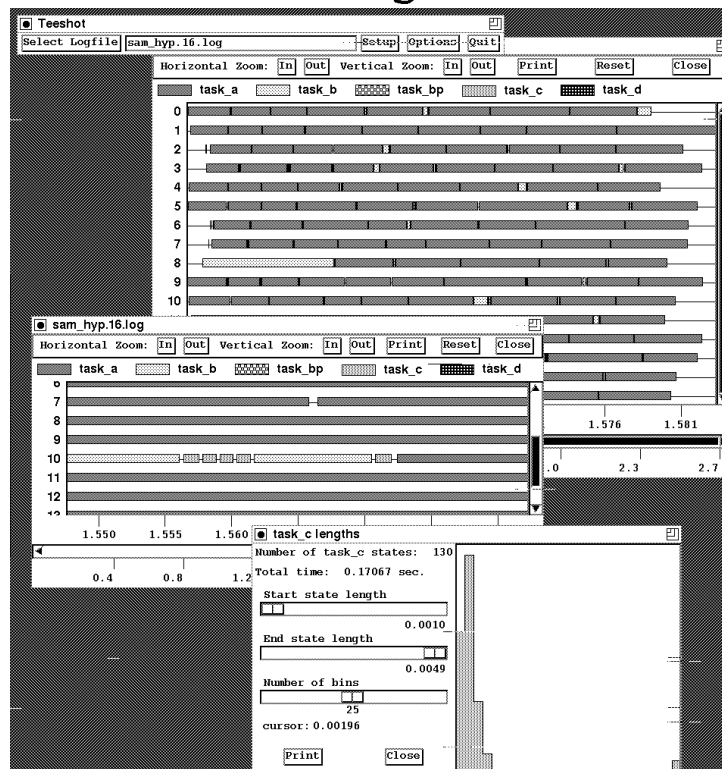

Generating a log file

This is very easy with the MPICH implementation of MPI. Simply replace `-lmpi` with `-llmpi -lpmpi -lm` in the link line for your program, and relink your program. You do not need to recompile.

On some systems, you can get a real-time animation by using the libraries `-lampi -lmpe -lm -lX11 -lpmpi`.

Alternately, you can use the `-mpilog` or `-mpianim` options to the `mpicc` or `mpif77` commands.

Connecting several programs together

MPI provides support for connection separate message-passing programs together through the use of *intercommunicators*.

Sending messages between different programs

Programs share `MPI_COMM_WORLD`.

Programs have separate and disjoint communicators.

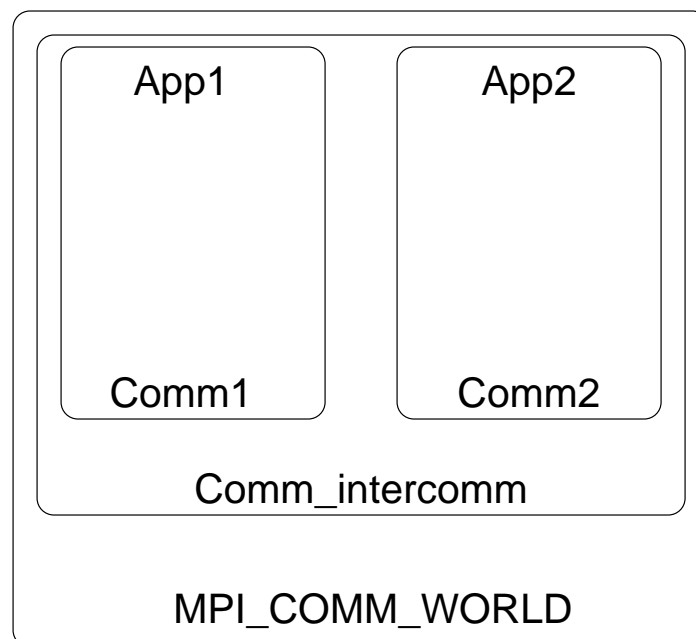

Exchanging data between programs

- Form intercommunicator
(MPI_INTERCOMM_CREATE)

- Send data

```
MPI_Send( ..., 0, intercomm )
```

```
MPI_Recv( buf, ..., 0, intercomm );
```

```
MPI_Bcast( buf, ..., localcomm );
```

More complex point-to-point operations
can also be used

Collective operations

Use `MPI_INTERCOMM_MERGE` to create an intercommunicator.

Final Comments

Additional features of MPI not covered in this tutorial

- Persistent Communication
- Error handling

Sharable MPI Resources

- The Standard itself:
 - As a Technical report: U. of Tennessee. report
 - As postscript for ftp: at `info.mcs.anl.gov` in `pub/mpi/mpi-report.ps`.
 - As hypertext on the World Wide Web: <http://www.mcs.anl.gov/mpi>
 - As a journal article: in the Fall issue of the Journal of Supercomputing Applications
- MPI Forum discussions
 - The MPI Forum email discussions and both current and earlier versions of the Standard are available from `netlib`.
- Books:
 - *Using MPI: Portable Parallel Programming with the Message-Passing Interface*, by Gropp, Lusk, and Skjellum, MIT Press, 1994
 - *MPI Annotated Reference Manual*, by Otto, et al., in preparation.

Sharable MPI Resources, continued

- Newsgroup:
 - `comp.parallel.mpi`
- Mailing lists:
 - `mpi-comm@mcs.anl.gov`: the MPI Forum discussion list.
 - `mpi-impl@mcs.anl.gov`: the implementors' discussion list.
- Implementations available by ftp:
 - MPICH is available by anonymous ftp from `info.mcs.anl.gov` in the directory `pub/mpi/mpich`, file `mpich.tar.Z`.
 - LAM is available by anonymous ftp from `tbag.osc.edu` in the directory `pub/lam`.
 - The CHIMP version of MPI is available by anonymous ftp from `ftp.epcc.ed.ac.uk` in the directory `pub/chimp/release`.
- Test code repository:
 - `ftp://info.mcs.anl.gov/pub/mpi/mpi-test`

MPI-2

- The MPI Forum (with old and new participants) has begun a follow-on series of meetings.
- Goals
 - clarify existing draft
 - provide features users have requested
 - make extensions, not changes
- Major Topics being considered
 - dynamic process management
 - client/server
 - real-time extensions
 - “one-sided” communication (put/get, active messages)
 - portable access to MPI system state (for debuggers)
 - language bindings for C++ and Fortran-90
- Schedule
 - Dynamic processes, client/server by SC '95
 - MPI-2 complete by SC '96

Summary

- The parallel computing community has cooperated to develop a full-featured standard message-passing library interface.
- Implementations abound
- Applications beginning to be developed or ported
- MPI-2 process beginning
- Lots of MPI material available